



BRAGER®

*We inspire  
an ecological climate*

We provide innovative solutions in the field of combustion that inspire all entities influencing the protection of the environment to care for the ecological climate.

[www.brager.com.pl](http://www.brager.com.pl)



ENERGY



## Solutions that matter

Trust in innovative, patented technologies

We create holistic solutions that optimize the entire combustion process in solid fuel boilers, which translates into a real reduction in pollution and allows everyone to join the fight for clean air. Our technologies are based on the scientific and research achievements of employees, in cooperation with the Poznań University of Technology. The company is managed by dr hab. Eng. Rafat Urbaniak, who has been studying combustion processes for many years, he is an author of patents and publications, court expert and external expert of PARP.

We know that further emission restrictions are inevitable, therefore, following the example of the automotive industry, we offer solutions that are ahead of the introduced standards.

**Find out how to gain an advantage by caring for an ecological climate.**

# Efficient production and distribution of thermal energy

01

Discover the innovative devices from the BORD line for the production of thermal energy and regulation of the combustion process.

We offer a number of innovative solutions that improve thermal comfort in rooms and always guarantee optimal combustion of solid fuels. The BORD line consists of devices for remote control of the heating installation, automation systems for pellet, charging and automatic boilers, expansion modules as well as wired and wireless room regulators.

Take control.

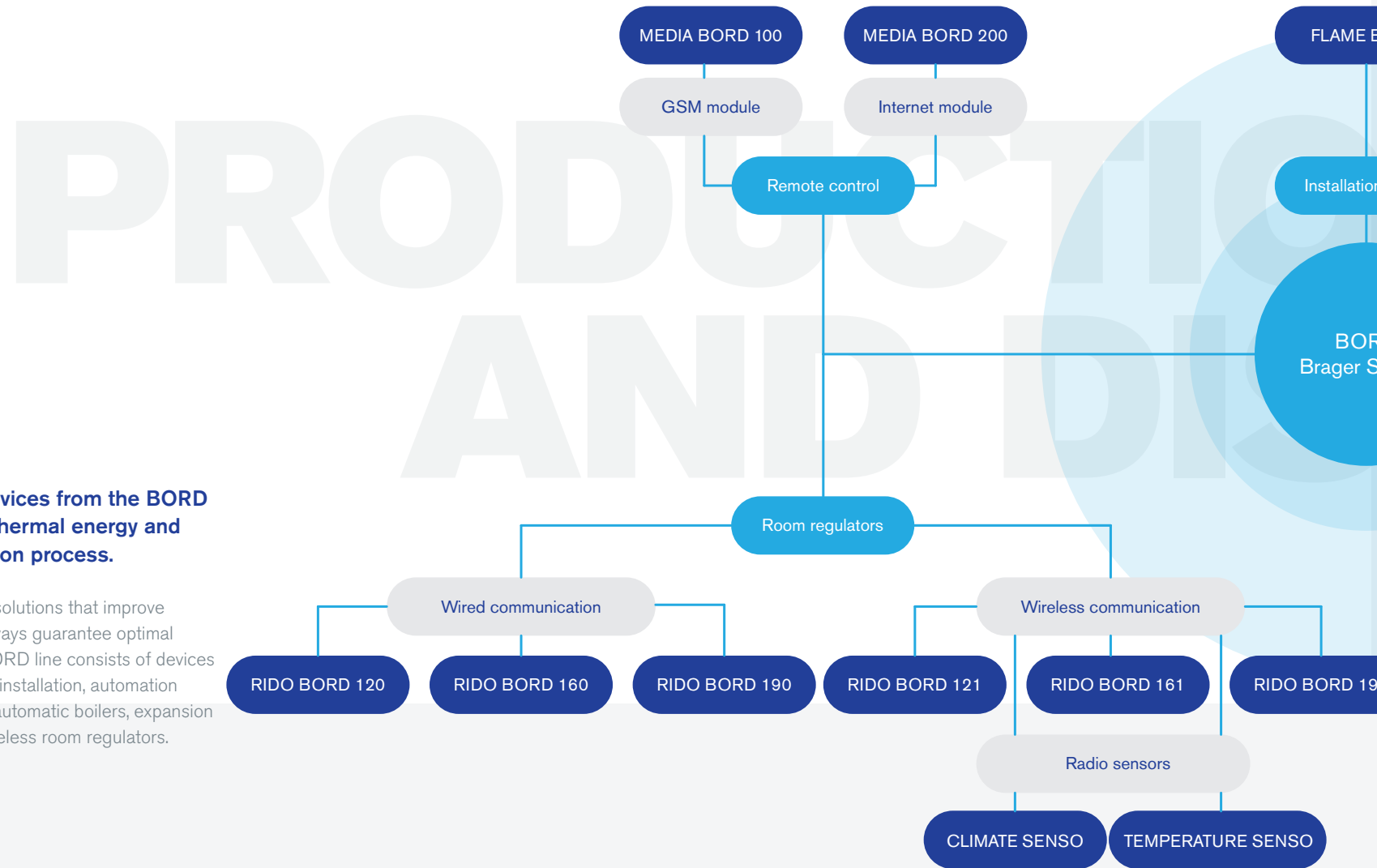

# 02

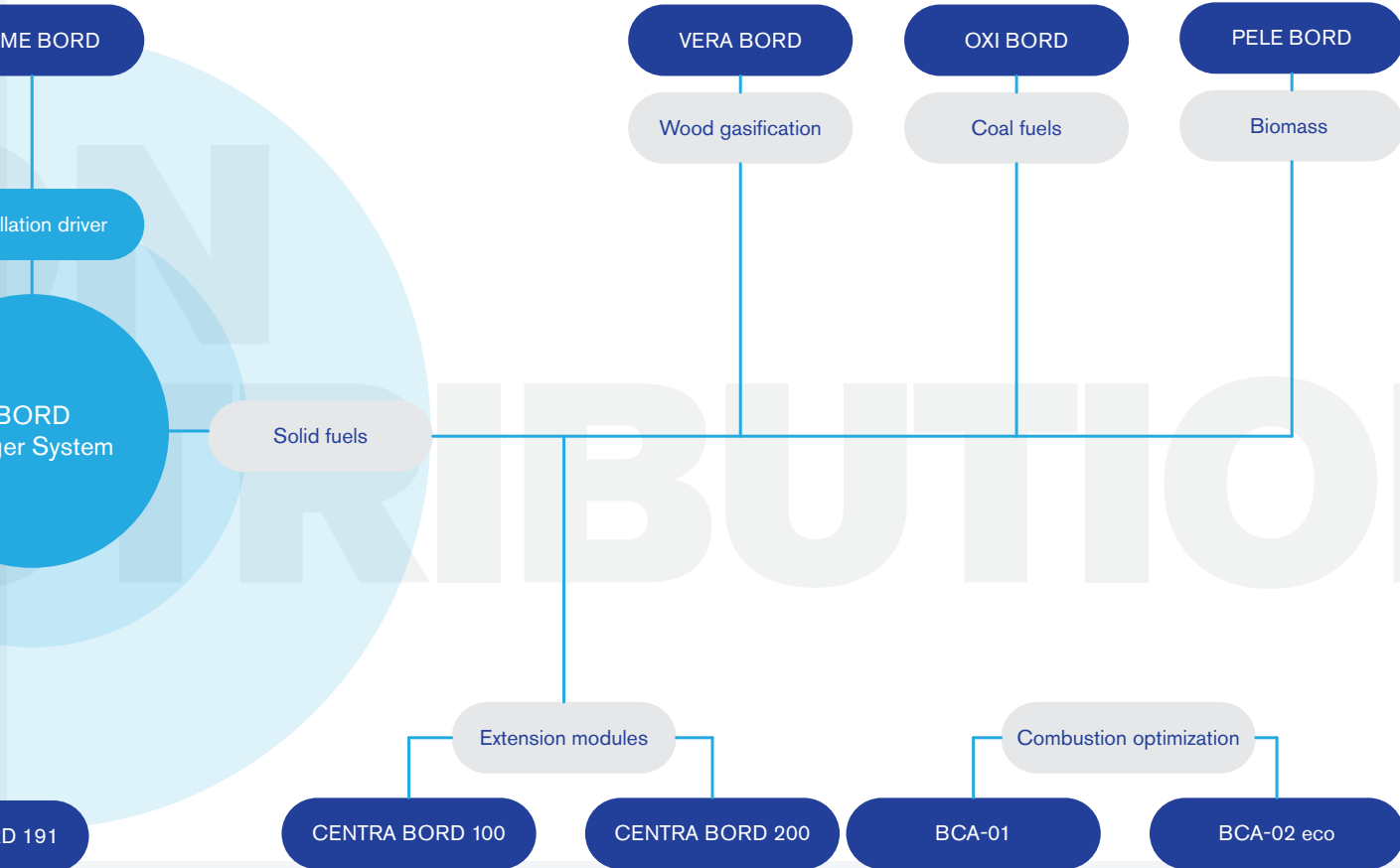

**By choosing devices from the BORD line, you support the idea of clean air and gain many benefits.**

You have constant, full control over even complex heating installations. You increase the value of boilers by ensuring environmentally and human-friendly, maintenance-free and efficient burning. You feel safe because you use the comprehensive help of our specialists. Thanks to the use of recognizable and proven solutions, you regularly gain new customers.

**Get an advantage.**

## Intuitive operating interfaces

Control devices from the BORD line ensure clear, simple and precise management of the installation.

By combining an innovative approach to building an interface with a large, clear, colour display and original design, we set new standards in the segment of devices for monitoring the combustion process in solid fuel boilers.



## OXI BORD 640



- Simple operation
- Clear screen
- Economical choice

## OXI BORD 760



- Intuitive operation
- Colour display
- Clear menu
- The best in its pricing range

# OXI BORD 780



- Large touch screen
- Precise controls
- Modern design
- Installer Mode

# OXI BORD 890



- The ability to use gestures
- Clear display and simple menu
- Pioneering functions
- Automatic backlight brightness adjustment
- Generating charts

## What else distinguishes our control panels?

- Availability of multilingual modes
- Automatic parameter hide function
- Icons corresponding to individual elements of the boiler / installation
- Flexible installation (e.g. in a boiler or on a wall)



## Innovation in operating pellet boilers

Discover the PELE BORD control automatics that guarantee efficient, uninterrupted and environmentally friendly operation of the pellet boiler.

Pellets are currently one of the cleanest and most ecological fuels. By combining a pellet boiler with PELE BORD controllers, you offer your customers environmentally and human-friendly, maintenance-free burning with a minimum amount of ash, and you give them solutions that exceed the current emission standards.



## PELE BORD 760

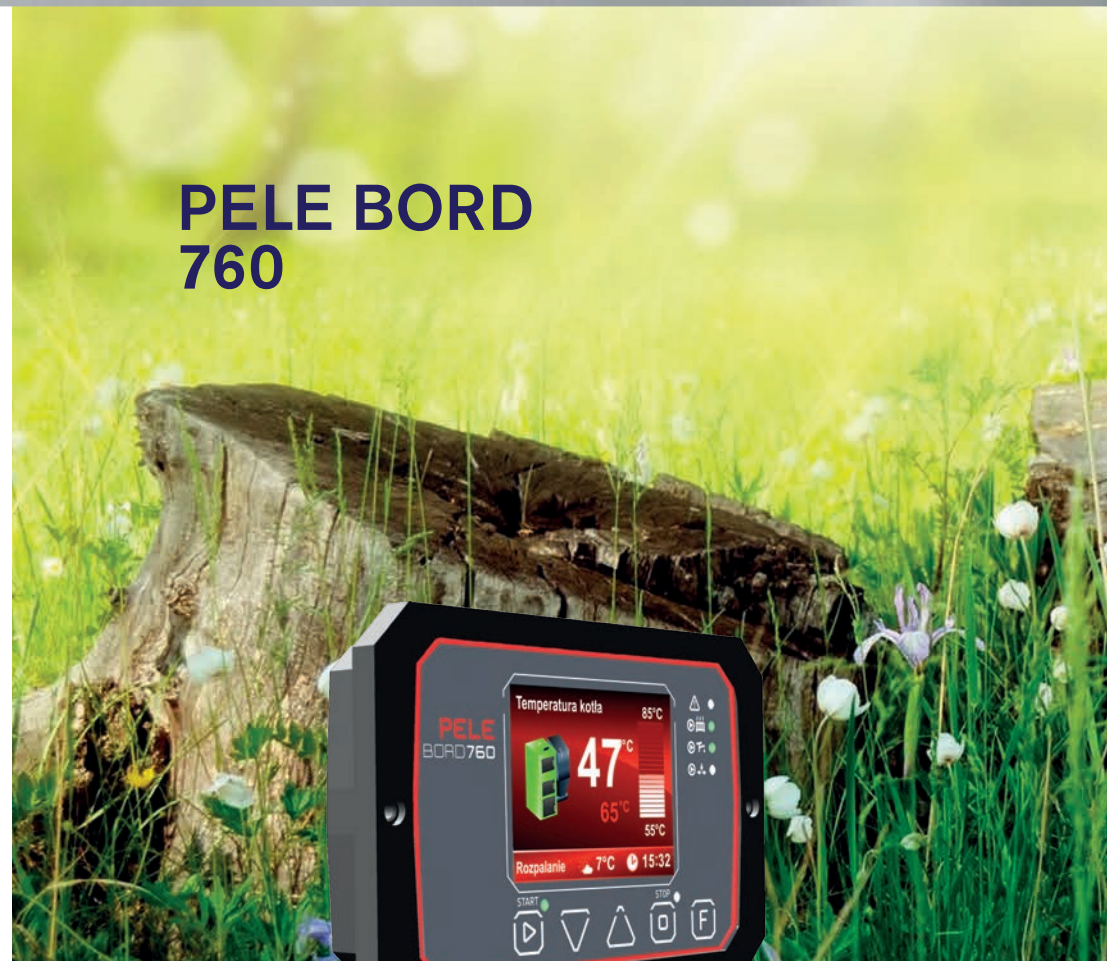

- Modern regulation algorithm
- Comprehensive control
- Clear TFT display
- Multilingual mode



## PELE BORD 780



- Innovative BRAGER EXPERT algorithm
- 4.3" color touch panel
- Management via smartphone
- Advanced Installer Mode

## PELE BORD 890



- The ability to use gestures
- Clear display and simple menu
- Pioneering functions
- Automatic backlight brightness adjustment
- Generating charts



### PELE BORD drivers:

- ensure fully automatic regulation of the boiler operation
- enable precise control over an extensive installation
- offer convenient remote management via a mobile application



# How easy is it to expand the installation?

We offer extension modules that allow you to add many new elements to the heating system.

## Our solutions are:

easily configurable  
clearly visible to the system  
designed by us from scratch

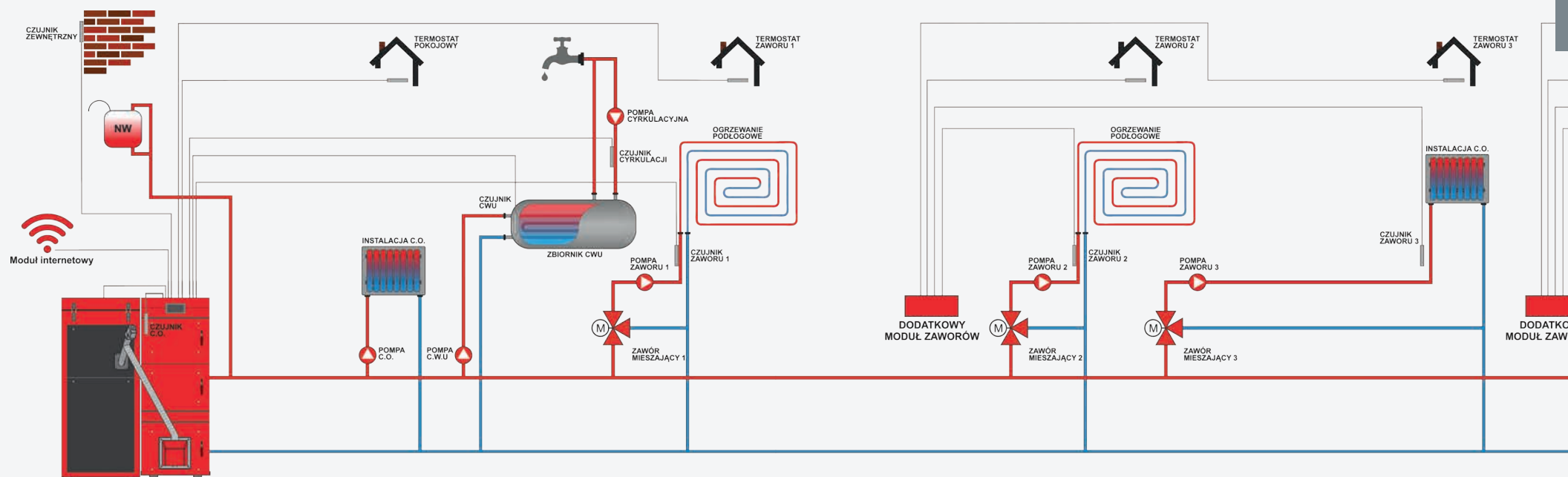

Do you want to easily manage the operation of multiple heating circuits?



The CENTRA BORD 100 module significantly increases boiler automation functionality, enabling the connection of two additional mixing valves.

Selected boiler automatics allow to simultaneously connect up to two CENTRA BORD 100 modules, thus - to control up to four additional heating circuits.

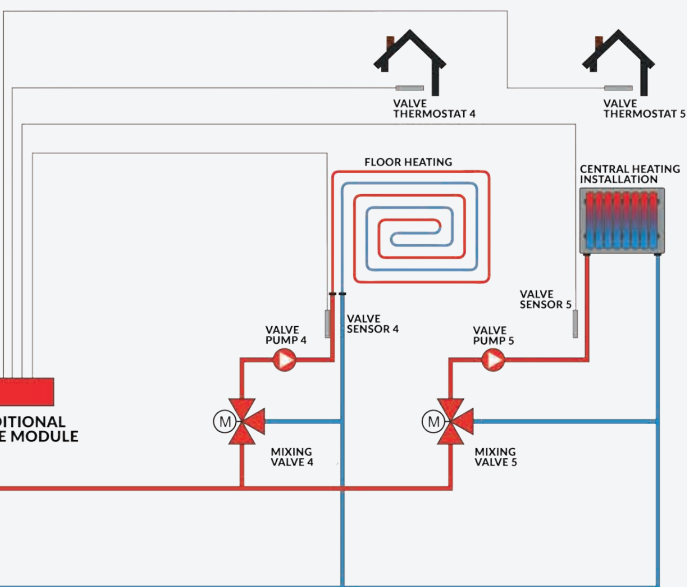

Our most advanced algorithm

The improved algorithm of automatic control of the BRAGER EXPERT combustion process ensures continuous, effective, maintenance-free operation of the heating system, contributing to the reduction of the level of pollutants emitted, increasing the boiler life and increasing thermal comfort.



# Discover the new, fully proprietary LIFE BORD™ system

The LifeBORD™ system intelligently integrates the components of the heating system to provide thermal comfort to everybody around it.

The system enables the integration of heating devices (solid fuel boilers, gas boilers, heat pumps), radiator and floor heating systems, measuring sensors and room thermostats. Its central element is a room panel from the RIDO BORD series, which, thanks to its proprietary operating interface, guarantees intuitive control and offers many innovative functions, such as

gesture control, measurement of lighting, light colour, humidity and temperature, and a quick assembly system. It also provides radio and Wi-Fi communication.

**Reach for the most modern.**



*We inspire an ecological climate*

# Room regulators

Discover the wide range of wired and wireless room thermostats from the RIDO BORD line.

These are innovative electronic devices that guarantee a comfortable temperature in heated rooms and enable remote control of the boiler and the entire heating system. Choose the optimal solution for you.

## What distinguishes our room regulators?

- Clear and intuitive user interface
- Large display
- Cooperation with any BRAGER automation
- Aesthetic design
- Innovative features

Wired communication			Wireless communication		
RIDO BORD 120	RIDO BORD 160	RIDO BORD 190	RIDO BORD 121	RIDO BORD 161	RIDO BORD 191



## Remote access to the installation

Thanks to BRAGER controllers, the user gains constant, remote control over the heating installation.

It can manage the boiler's operation via a smart-phone - regardless of where you are, 24/7. The controller connects to the Internet or GSM network using modern MEDIA BORD internet modules.

The MEDIA BORD 200 module extends the system's capabilities with remote access to all devices owned by the user.

**Both wired and wireless Internet connection is possible.**

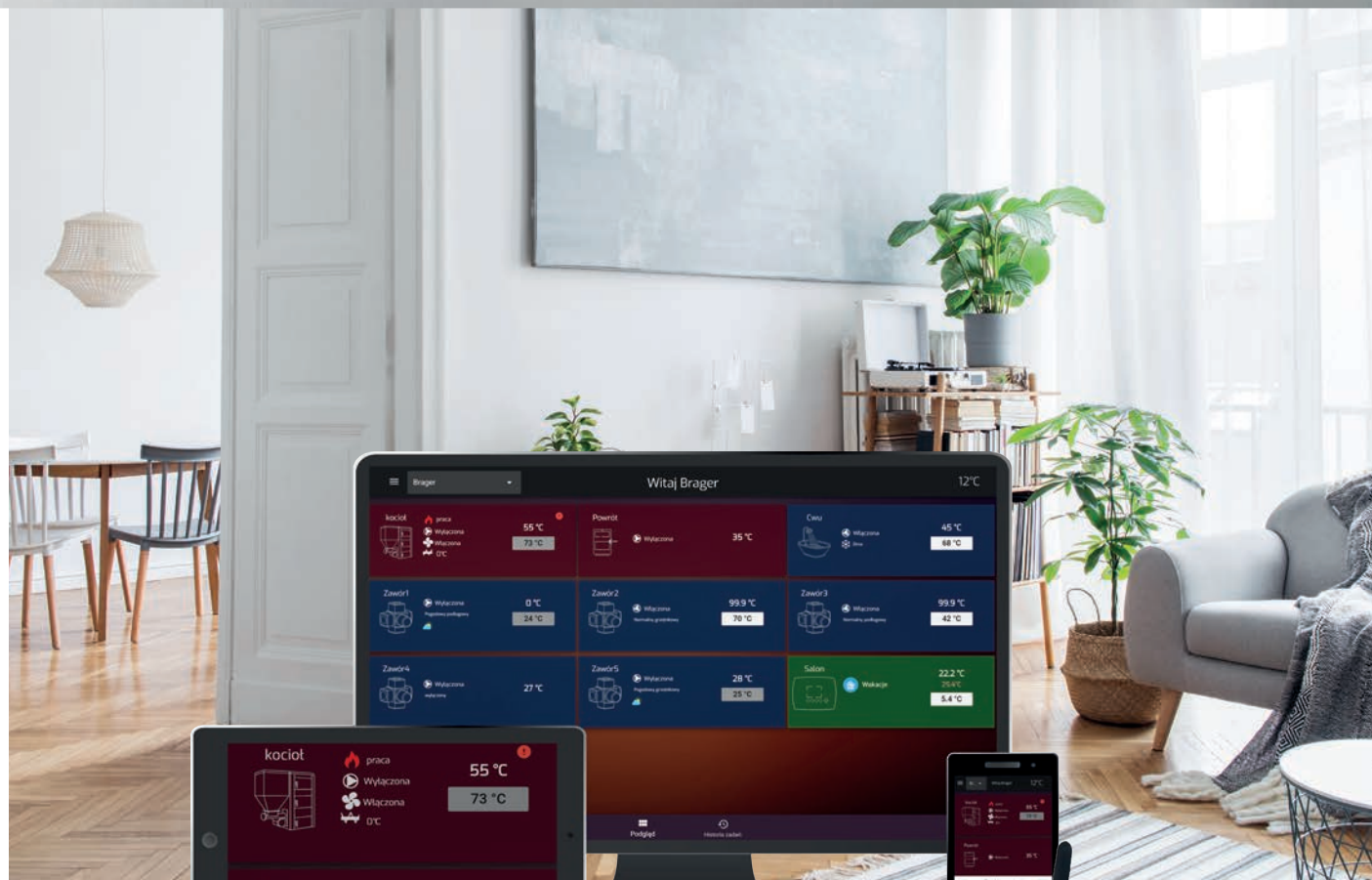

## Data security in every situation

Thanks to the built-in memory card, your data is safe - even in the case of temporary loss of connection to the network.



## BRAGER Connect

The BRAGER Connect application enables remote management of the heating installation from any device with Internet access.

The intuitive interface combined with a clear graphic design guarantees comfort, speed and ease of use, and a number of useful functions allow users to precisely control not only the boiler itself, but also the entire heating installation.

Gain access to the application on:

→ [cloud.bragerconnect.com](http://cloud.bragerconnect.com) – for stationary devices

→ [play.google.com](http://play.google.com) – for Android mobile devices

→ [itunes.apple.com/pl/app/bragercloud](http://itunes.apple.com/pl/app/bragercloud) - for mobile devices with iOS

The application is being constantly developed and improved by us.

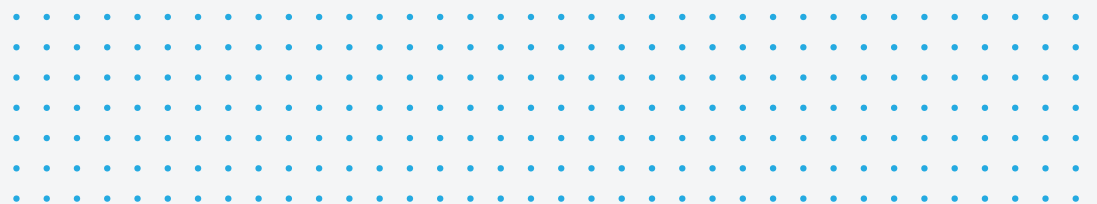



**eco7zone system**  
**- together for clean air**

Meet the pioneering solution that integrates and inspires all entities that have an impact on environmental protection to care for the ecological climate.

The eco7zone® system includes patented tools to optimize the combustion process and control pro-ecological activities (including boiler automation, combustion process analyzers and heat distribution system). It allows everyone to have a real impact on the cleanliness of the air in their environment.

Additionally, eco7zone® generates unique benefits for all groups involved in the project: public institutions, boiler manufacturers, installers and end users.

**We have a patent for it!**

eco7zone® - The algorithm of regulation and identification of incorrect operation of solid fuel boilers

"The layout and method of combustion process quality control in a solid fuel boiler with automatic burner powered by solid fuels"

**Patent No. 230943**



**#We make clean air – so can you**  
Find out more at [www.eco7zone.com](http://www.eco7zone.com)



# Combustion process analyzers

We are a leading Polish manufacturer of compact solutions for measuring the quality of the combustion process in solid fuel boilers.

A boiler equipped with intelligent automation and analyzer achieves the same efficiency as in the laboratory conditions and generates much less pollution. We have a number of patent applications that testify to the innovation and reliability of our solutions.

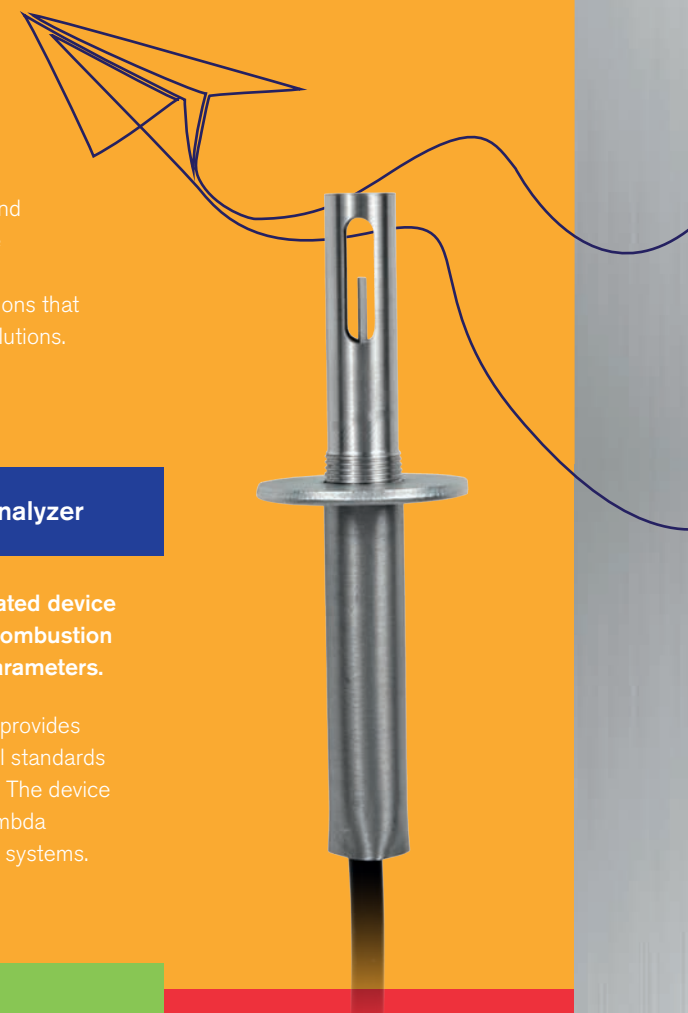

## BCA-01 Combustion Process Analyzer

This is a process optimization device for solid fuel combustion in medium and large power boilers. It allows to improve the efficiency of combustion processes by up to 10%.

The continuous, automatic, precise measurement of parameters (oxygen and carbon dioxide concentrations, excess air coefficient, exhaust gas temperature, chimney loss) in real time makes it possible to optimize the combustion process and to control the emission of harmful substances.

## BCA-02 eco combustion process analyzer

This is the world's first only boiler dedicated device that allow continuous measurement of combustion processes and automatic selection of parameters.

Thanks to the BCA-02 eco, the pellet boiler provides optimal operating parameters and meets all standards in real conditions (not only in the laboratory). The device is cheaper and more resistant to dirt than lambda probes. Works with all fuel types and control systems.

## We have a patent for it!

"The analyzer of combustion process quality in boilers for solid fuels"

**Utility model no. Ru.070142**

"The analyzer of combustion process quality for small power boilers fired with solid fuels"

**Patent application No. P.434710**

"Oxygen concentration analyzer housing for small power boilers fired with solid fuels"

**Application for a European industrial design no.008050785**





## After-sales support

Sale is only a stage of cooperation. By choosing our solutions, you benefit from professional service care.

We provide warranty and post-warranty service. If you need technical assistance, we remain at your disposal. We work in such hours as installers, manufacturers and distributors of boilers. We respond to service requests within max. 24h.

Contact with the service:

 **795 750 933**

 **[serwis@brager.com.pl](mailto:serwis@brager.com.pl)**





## Are you interested in our solutions?

Get to know them in practice.  
We are happy to talk and advise

**BRAGER Sp. z o.o.**

ul. Rolna 11  
63-300 Pleszew

✉ [kontakt@brager.com.pl](mailto:kontakt@brager.com.pl)

☎ 795 750 970

NIP: 6222785743

REGON: 302755012

[www.brager.com.pl](http://www.brager.com.pl)



**BRAGER<sup>®</sup>**



[www.brager.com.pl](http://www.brager.com.pl)